

Air Riveter

MODEL: ARV-022M

Operation Manual

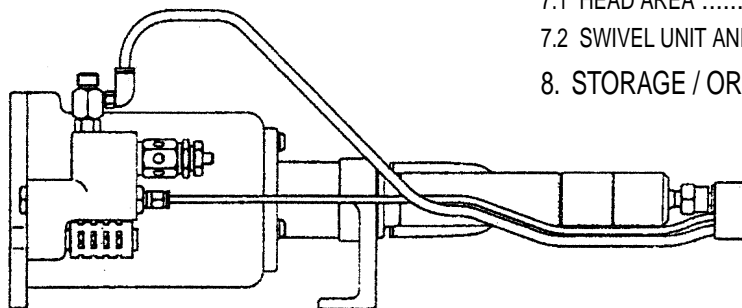
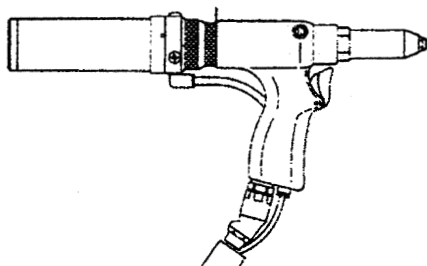

- CONTENTS -

1. SAFETY	3
1.1 WARNING SIGN	3
1.2 SAFETY CONCERNS	3
1.3 SAFETY VALVE	5
2. NAME AND SPECIFICATION OF EACH PART	6
3. PREPARATION BEFORE USE	7
4. HOW TO RIVET	9
5. CLEANING AND MAINTENANCE	10
5.1 FRAME HEAD AND JAW CASE UNIT	10
5.2 SPOOL UNIT	11
5.3 CYLINDER UNIT	12
5.4 CHECKING HYDRAULIC OIL	13
5.4 DISCONNECTING HYDRAULIC COUPLER	14
5.5 NOZZLE UNIT	15
6. TROUBLESHOOTING	16
7. PART DRAWINGS	17
7.1 HEAD AREA	17
7.2 SWIVEL UNIT AND BOOSTER UNIT	19
8. STORAGE / ORDERING PARTS	20

Be sure to read this manual before use.

Store this manual with care so that you can refer to it whenever necessary.

INTRODUCTION

- The Lobster Tool Air Riveter, ARV-022M is an exclusive tool for Blind Rivet fastening two boards by riveting. We do not design, manufacture or sell intending to other applications.
- This operating manual (called “This manual” afterwards) describes how to use the tool safely and effectively, how to do check and maintenance, and parts information.
- Use rivets for the tool with the specification and strength thoroughly designed and examined.

IMPORTANT NOTICES

- Read this manual carefully before using this tool. Follow instructions in this manual for handling this tool, replacing accessories or replacing parts.
- If you have any questions about this manual, consult with the store you purchased this tool or Lobtex Co, Ltd. You may be asked model name or model number.
- It is impossible to foresee all potential dangers and describe them in this manual. You must use this tool with paying enough attention to safety as well as observing the instructions in this manual.
- It is user’s responsibility to understand the contents of this manual thoroughly.
- Lobtex Co., Ltd. has the copyright of this manual. It is prohibited to publish, copy or translate to other language without prior consent.

IMDEMNIFICATION





- Customer agrees to indemnify and hold Lobtex harmless against any damage, loss, liability or expense arising out of;
 - 1) Direct or indirect damage or loss caused by abuse, misuse or unauthorized remodeling.
 - 2) Damage or injury caused by reconstruction or remodeling without Lobtex written authorization.
 - 3) Damage or injury caused by use of parts other than recommended parts by Lobtex.
- Rivet itself is not covered under warranty.

1. SAFETY

Followings are safety items to handle this tool.

1.1 WARNING SIGN

This manual includes warning signs shown below to protect users from possible injuries or damages to properties. There are different signs depending on the level of potential damage in case of negligence. For safety, follow the instructions by all means.

Warning Sign	Descriptions
	Indicates a potentially hazardous situation which, if not avoided, could result in death or serious injury.
	Indicates a potentially hazardous situation which, if not avoided, may result in moderate injury.
	Indicates a potentially hazardous situation which, if not avoided, may result in property damage.
	This sign emphasizes important or beneficial information.

1.2 SAFETY CONCERNS



Connect the tool and air source firmly.

Mismatched pipe arrangement in the joint screw and/or insufficient fitting length may give air hose disconnection to cause injury.

When the auxiliary air hose joint is used, connect it firmly with a hose band so that the air hose should not be disconnected.

Confirm no damages in each part. If you see any damage, repair or replace it.

If you use the tool without repair, the damaged area may be broken and may cause injury. If something falls on the tool and air hose is damaged, the damaged area may be broken and may cause accident or injury.

Keep the air pressure between 0.49 and 0.59 Mpa (5 to 6 kgf/cm²).

Exceeding the air pressure limits may result in possible damage to the tool to cause injury.

Always use the tool with the tank unit. During use, wear safety glasses.

Cut rivet shafts may be blasted off and may cause injury.

1. Safety

When a chute hose is used instead of a tank unit, do not direct the end of the chute hose (vent of cut rivet shafts) toward any person.

Cut rivet shafts may be blasted off from the end of the chute hose and may cause injury.

If you use the tool at high location, be careful not to drop the tool or rivets as well as protecting yourself from dropping.

Carelessness may cause accidents or injury.

Before cleaning or maintenance of this tool, make sure that the power of the air compressor is turned off to stop air supply and delete residual pressure in the air circuit.

Cleaning or maintenance operation during air supply may cause injury.



Do not operate this tool with the frame head detached.

Otherwise, your finger or a hand may be pinched.

Keep your body or face away from silencer area.

Oil content may be blasted off from silencer area and may come into your eyes.

Do not remove rubber bellows at swivel joint in the end of oil pressure hose.

Otherwise, your finger or a hand may be pinched.

Do not remove the protective tube that enfolds oil pressure hose. If protective tube is damaged, stop using it and repair or replace it.

Protective tube protects oil pressure and prevents danger in case that oil pressure hose is broken. Dysfunction of protective tube may cause accident or injury.

This tool must be used at organized, uncluttered and clean place.

Operation at cluttered place may lead to accident or injury.

Do not operate with uncomfortable body position.

It may cause injury such as falling down.

Keep the grip area dry and clean condition and away from oil or grease. If the area gets oil-stained, remove it. Oily grip area may lead to injury.

Understand handling method and operating method thoroughly and operate carefully.

Follow instructions in this manual and do not use for any other purposes than intended purpose.

Use for other purposes may cause accidents or injury.

Do not use this tool when you feel sick.

Use the tool with bad physical condition may cause accidents or injury.

If you need repair, consult with the store you purchased this tool or Lobtex Co, Ltd.

Repairing with lack of knowledge or technique may not be able to fix the tool properly and may cause accident or injury.

Do not attempt to modify the tool at any rate.

Modification or remodeling may lead to malfunction, accident or injury.

Any modification made by the customer will void the warranty.

When you handle oil or grease, obtain the material safety data sheet (MSDS) from the supplier, and follow the described instructions.

1.3 SAFETY VALVE

This tool incorporates a “safety valve” that blows off air to indicate the abnormality when too much air is supplied to the riveter.

Pressure: 0.49 to 0.59 MPa (5 to 6 kg/cm²)

Blow off air pressure: 0.64MPa(6.5kg/cm²)

Procedure in case that the valve blows off:

Appropriate air

- (1) Stop using the tool immediately, and stop the air supply.



Safety valve cannot be reset without stopping air supply.

- (2) Setup the air pressure to the range between 0.49 and 0.59 MPa (5 to 6 kg/ cm²).
- (3) Supply air again and confirm that the safety valve does not blow off.



Safety valve must not be removed or disassembled. Safety valve is an especially important safety device. If it is accidentally loosened or damaged, consult with the store you purchased the tool or Lobtex Co, Ltd.

CAUTION

- **Do not use the tool without resetting safety valve after it blows off. It may cause damage of the tool.**
- **If safety valve still blows off after adjusting air pressure, stop using the tool and consult with a sales office of Lobtex Co, Ltd.**

2. Description of Each Part

2. NAME AND SPECIFICATION OF EACH PART

The following figures show name and specification of each part.

2.1 NAME OF EACH PART

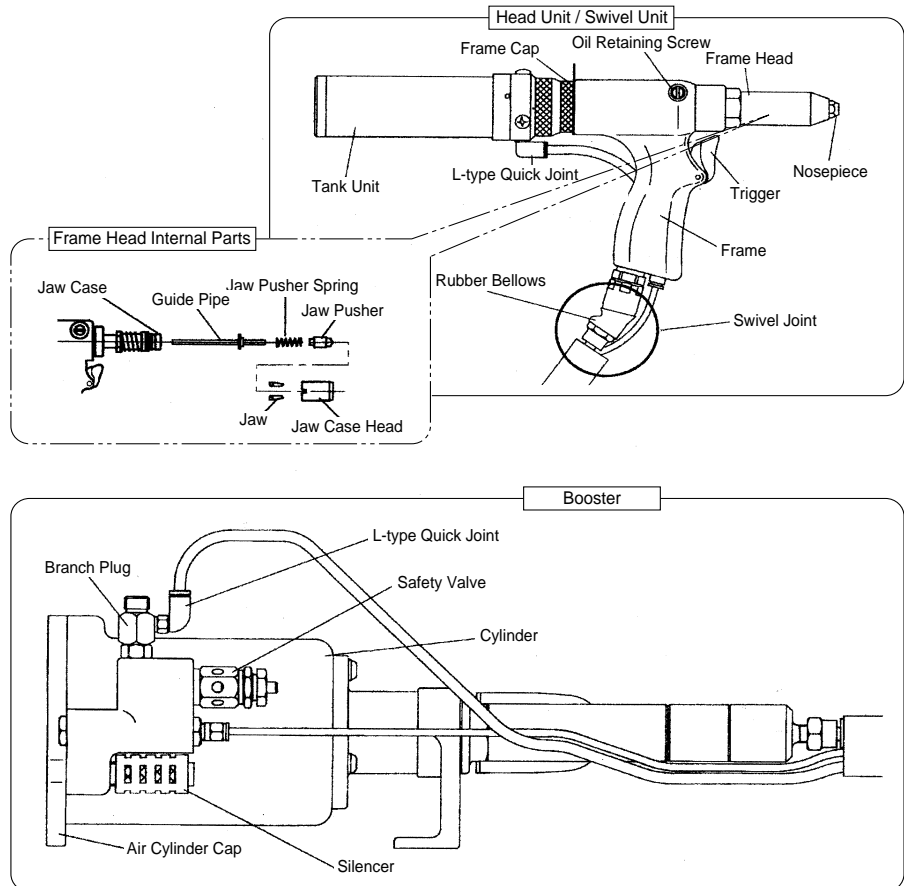

2.2 SPECIFICATION

Model Number	ARV-022M	
Weight	Head	1.3kg
	Total	5.0kg
Working Air Pressure	0.49-0.59Mpa(5.0-6.0kgf/cm ²)	
Air Consumption	100liters/min	
Tool Stroke	19mm	
Traction Power at 0.49MPa(5kgf/cm ²)	8825N(900kgf)	
Usable Rivets	2.4 3.2 4.0 4.8 mm diameter	
Usable Jaw	Hard tool material jaw, Medium	



Specification and design of this product are subject to change without notice.

3. PREPARATION BEFORE USE

The tool must be prepared by the following procedure:

- (1) Set up a correct nosepiece and a correct guide pipe according to the size of rivet to be used.



Default setup is 3.2 mm-diameter nosepiece and yellow guide pipe.

Rivet Size (Rivet Diameter)	Nosepiece Die Stamp	Guide Pipe
φ 2.4	2.4	A(Yellow)
φ 3.2	3.2	
φ 4.0	4.0	B(White)
φ 4.8	4.8	

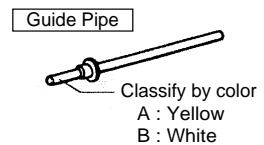
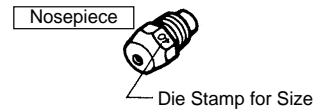
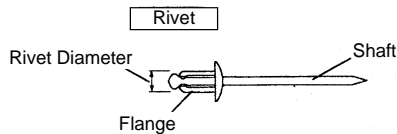

- (2) Fix a tank unit and or a chute hose (optional parts). Following is the procedure to use a chute hose.

- Insert the end of chute hose to the nozzle unit fully.
- Fix the other end of the chute hose to the storage case securely so that it does not loose during operation. There must be enough space in the end of the chute hose. Lack of space or obstacles in the end of the chute hose may prevent a shaft of cut rivet from being discharged or cause degradation in discharge power.

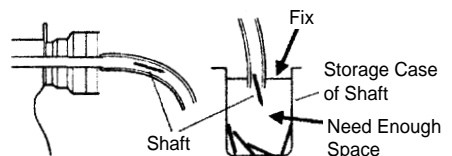
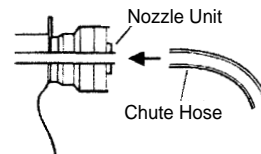
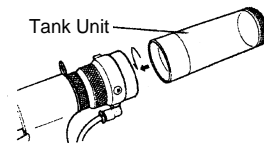

3. Preparation Before Use

- (3) Prepare an air compressor. Be sure to place an air filter and an air regulator between the compressor and the air riveter.

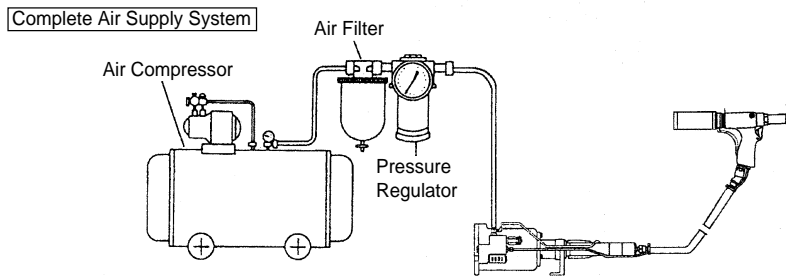

- (4) Set up 0.49 to 0.59 Mpa (5 to 6 kgf/cm²) as air pressure.

CAUTION

Too much pressure may cause damage to the tool. Too low pressure may cause incomplete rivetting or incomplete cutting.

- (5) Make sure that the tool works properly.

After connection with air, make sure that the tool works smoothly without oil leak by idle run (operating 2 or 3 times without rivets).



The tool needs careful cleaning and maintenance if it is not used for a long time. (Ref: "5.1 Frame head and jaw case") After cleaning and maintenance, vacuum mechanism must be operated before use.

4. HOW TO RIVET

Following is the procedure for riveting:

(1) Drill a prepared hole (0.1 to 0.2mm larger than the flange diameter of the rivet) in the material to be riveted.

(2) Turn the switch ring of vacuum device to ON to activate the device.

- The vacuum device is activated. You can hear the vacuum noise.



Crimping operation is possible even without vacuum activation. However, the next crimping operation must be done only after the cut shafts are evacuated.

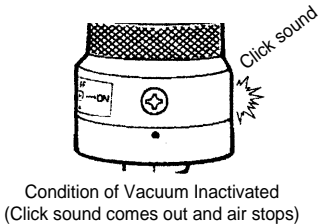
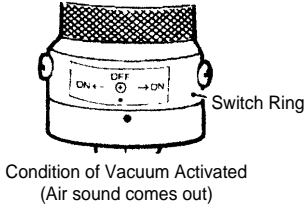

(3) Insert a rivet shaft into the Nosepiece of the riveter.



Rivet is not dropped because it is vacuumed up.

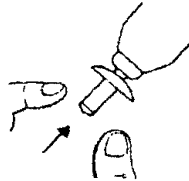

(4) Insert the rivet flange into the work piece hole.

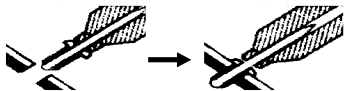

(5) Press the flange collar onto the material and pull the trigger.

- The flange is crimped.

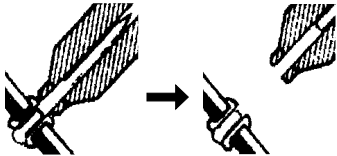

(6) When the trigger is released, the shaft is automatically evacuated in the tank unit.



The Next crimping operation must be done only after the cut shaft is evacuated.

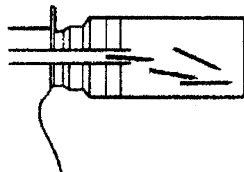

5. Cleaning and Maintenance

5. CLEANING AND MAINTENANCE

Riveting for a long time generates chips and dust at several parts, which causes troubles. The tool needs periodical cleaning and maintenance according to this manual.



Before cleaning and maintenance of each part, make sure that the power of air compressor is turned off to stop air supply and eliminate the residual pressure. Otherwise, you may be injured.

CAUTION

- When assembling each part, apply lubricant agent such as grease at each sliding area without fail. Otherwise, malfunction may occur.
- All parts must be completely assembled and all fastening areas must be fastened.

5.1 FRAME HEAD AND JAW CASE UNIT

If chips are clogged, jaw cannot work smoothly. Cleaning must be performed in every 3000 times of crimping.



- Jaw is a consumable supply. It must be replaced periodically. This tool uses high-endurance hard tool material jaw (optional parts). When you order the part, order “hard tool material jaw, medium”.
- Do not loosen or remove an oil retaining screw. The oil retaining screw is used for air vent during assembly.
- Do not loosen or remove a jaw case or lock nut of jaw case. If it is loosened or removed, oil is leaked from head area, which cause malfunction. Jaw case and lock nut of jaw case are mounted at screw unit of oil piston so that they are not loosened. If they are accidentally loosened during operation or during maintenance, ask repair.

Disassembly

- (1) Stop air supply.
- (2) Remove the frame head with auxiliary spanner A.

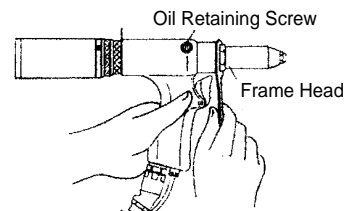

5. Cleaning and Maintenance

- (3) Pull Collar to the direction shown in the figure to loosen jaw case head and remove it.

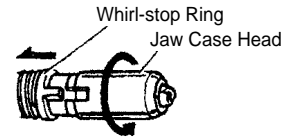

- (4) Remove jaw pressure spring, guide pipe, jaw pressure and jaw.

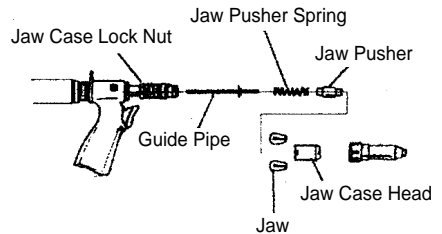

Cleaning

- (5) Clean up each part with a brush.

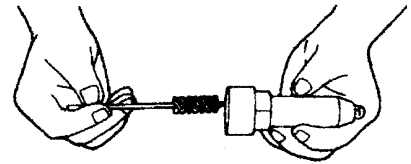

Assembly

- (6) Assemble parts in reverse procedure of disassembly. Wind and tighten jaw case head to the end and return it to the position where convex and notch are aligned, then set up Collar. At assembly, apply lubricant oil on the backside of jaw.

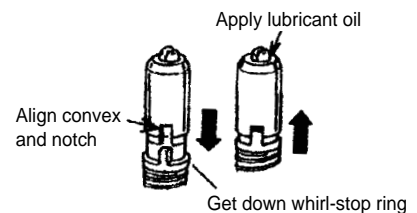

5.2 SPOOL UNIT

If dust is accumulated at spool area, spool cannot move smoothly. Spool must be cleaned when spool moves slowly or improperly.

Disassembly

- (1) Stop air supply.
- (2) Remove spool cap A and B with a spanner.

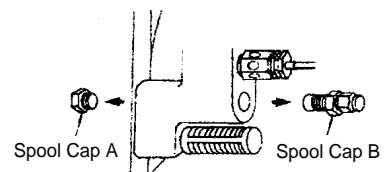

5. Cleaning and Maintenance

- (3) Push up the spool with a plastic stick that does not hurt it, and remove the spool.

Cleaning

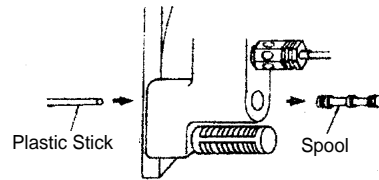

- (4) Clean up each part with a brush. In this case, make sure that the small hole of the spool is not plugged.

Assembly

- (5) Assemble parts in the reverse procedure of disassembly. At assembly, apply lubricant oil on the O-ring of the spool.

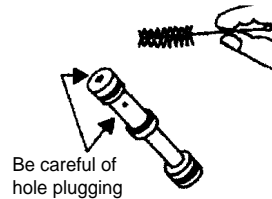

5.3 CYLINDER UNIT

Accumulation of dust at cylinder area negatively affects smoothness and durability of the cylinder. Cylinder must be cleaned every one month.

Disassembly

- (1) Stop air supply.
- (2) Remove 3 screws by hexagon wrench (M5), and remove the air cylinder cap.

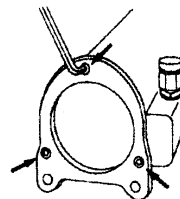

- (3) Stand the cylinder upward vertically. Pull out the air piston with pliers.



Cylinder must stand. If it lays down, hydraulic oil is leaked.

Cleaning

- (4) Clean up inside of cylinder, and apply grease.

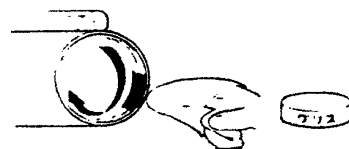

Assembly

- (5) Assemble parts in reverse procedure of disassembly. When assembly, apply lubricant oil on the O-ring of the air piston.

5.4 CHECKING HYDRAULIC OIL

Generally, riveting is completed by only one trigger operation. However, if hydraulic oil is decreased, multiple trigger operations are needed. In this case, hydraulic oil must be checked.

Checking

- (1) Stop air supply.
- (2) Stand the booster, wind the oil tank cap counterclockwise, and remove it.

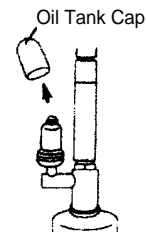

- (3) Check the status of internal tank. If the internal tank shrinks or gets smaller, the tank does not have enough hydraulic oil. In this case, the tank must be filled with oil as in the following procedure:

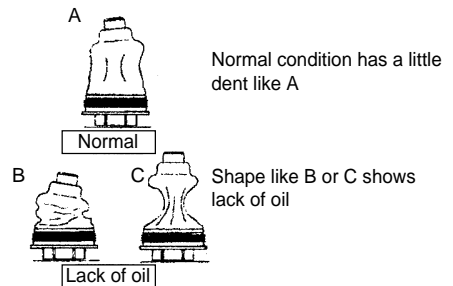

Lubricating

- (4) Remove the cap.

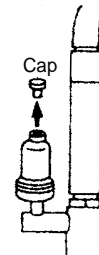

- (5) Fuel proper amount of oil. Fill up the oil by supporting the tank carefully to see if the oil does not overflow.

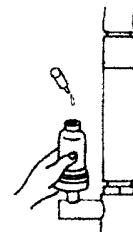

5. Cleaning and Maintenance

CAUTION

Make sure to use Lobtex's hydraulic oil. Other manufacturer's oil may affect the tool's performance negatively.

- (6) Press the tank lightly not to allow air to go into the tank and replace the cap and the oil tank cap.

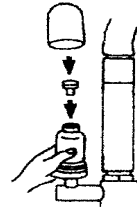

5.4 DISCONNECTING HYDRAULIC COUPLER

In some cases, disconnecting head area from booster area makes it easier to do maintenance work or refueling. In that case, disconnect hydraulic coupler as following procedure:

Disassembly

- (1) Stop air supply.
- (2) Remove the coupler bag by a spanner.

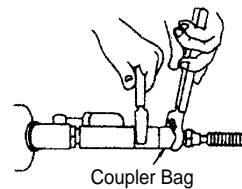

- (3) Pull out the male coupler.

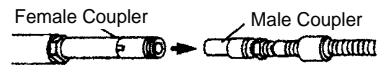

Assembly

- (4) Stand the booster and pour the oil to the B-ring line of the male coupler.

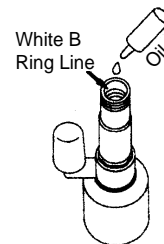

- (5) Press-in the male coupler and wipe out the leaked oil.
- (6) Fasten the coupler bag with a spanner.

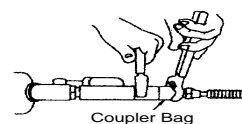
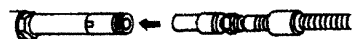

5.5 NOZZLE UNIT

If dust is accumulated at nozzle unit, power of vacuuming rivet's shaft weakens. If power of vacuuming shaft is getting weak, check as following procedure:

Disassembly

- (1) Stop air supply.
- (2) Remove the tank unit or the chute hose.
- (3) Remove the nozzle unit from the main unit by a spanner.
- (4) Disconnect the nozzle unit A from the nozzle unit B.



They are connected a little tight. Therefore, disconnect them by pliers. Be careful not to hurt the O-ring attached with the nozzle A.

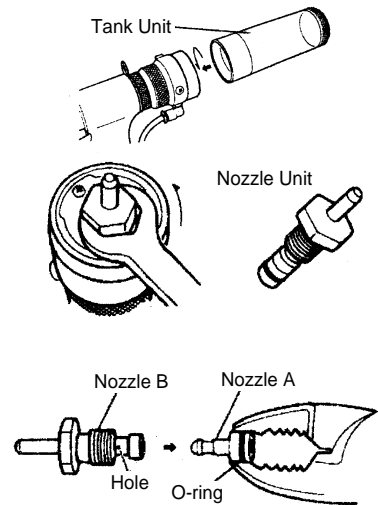

Cleaning

- (5) Clean carefully inside of the tube of the nozzle A and the nozzle B, and the small hole of the nozzle B.

Assembly

- (6) Assemble parts in reverse procedure of disassembly.

6. Troubleshooting

6. TROUBLESHOOTING

When any breakage is suspected, try following procedures. If the following procedures cannot solve the problem, consult with Lobtex or ask repair.

Malfunction	Possible cause	Countermeasures
Rivets cannot be inserted, or shafts cannot be discharged after cut.	<ol style="list-style-type: none"> 1. Nosepiece is wrongly used. 2. Nosepiece or frame head is loosened. 3. Jaw does not contact with jaw case head properly. 4. Size of guide pipe is improper, or guide pipe is missing. 	<ol style="list-style-type: none"> 1. Use proper Nosepiece with the rivet size. (P7) 2. Tighten them up completely. 3. Clean up the taper area of jaw case head, and apply lubricant oil to back side of jaw. (P10) 4. Attach proper guide pipe with the rivet size.
Crimping cannot be completed with one trigger operation.	<ol style="list-style-type: none"> 1. Rivet size is improper with the plate thickness. 2. Air pressure of compressor is improper. 3. Jaw is worn. 4. Jaw case head is not attached properly. 5. Piston stroke is not enough due to lack of hydraulic oil 	<ol style="list-style-type: none"> 1. Use proper rivet. 2. Adjust air pressure. (P.8) 3. Replace jaw with a new one. (P.10) 4. Wind and tighten jaw case head to the end and return it to the position where convex and notch are aligned, then set up Collar. (P.11) 5. Refill hydraulic oil. (Oil piston stroke is 19 mm). (P.13)
Abnormal operation such that piston does not work or moves slowly.	<ol style="list-style-type: none"> 1. Spool does not work properly. 2. Spool does not work properly because silencer is clogged. 3. Air piston does not work properly due to dirty inside of cylinder or lack of oil. 	<ol style="list-style-type: none"> 1. Clean up spool (P.11) 2. Replace silencer with a new one. 3. Clean up the inside of cylinder. (P.12)
Power of vacuuming rivets is weak, or shafts are not discharged.	<ol style="list-style-type: none"> 1. Tank is full with shafts. 2. Guide pipe of riveter is clogged with shafts. 3. Nozzle unit is dirty. 4. Chute hose is clogged with shafts. 5. Nozzle unit is clogged with shafts. 	<ol style="list-style-type: none"> 1. Detach the tank unit and make it empty. 2. Detach the guide pipe and remove shafts. 3. Clean up the nozzle unit. (P.15) 4. Detach the chute hose and remove shafts. 5. Detach the nozzle unit and remove shafts. 6. Use specified chute hose.

7. PART DRAWINGS

7.1 HEAD AREA

Head Unit is consisted of the following parts:

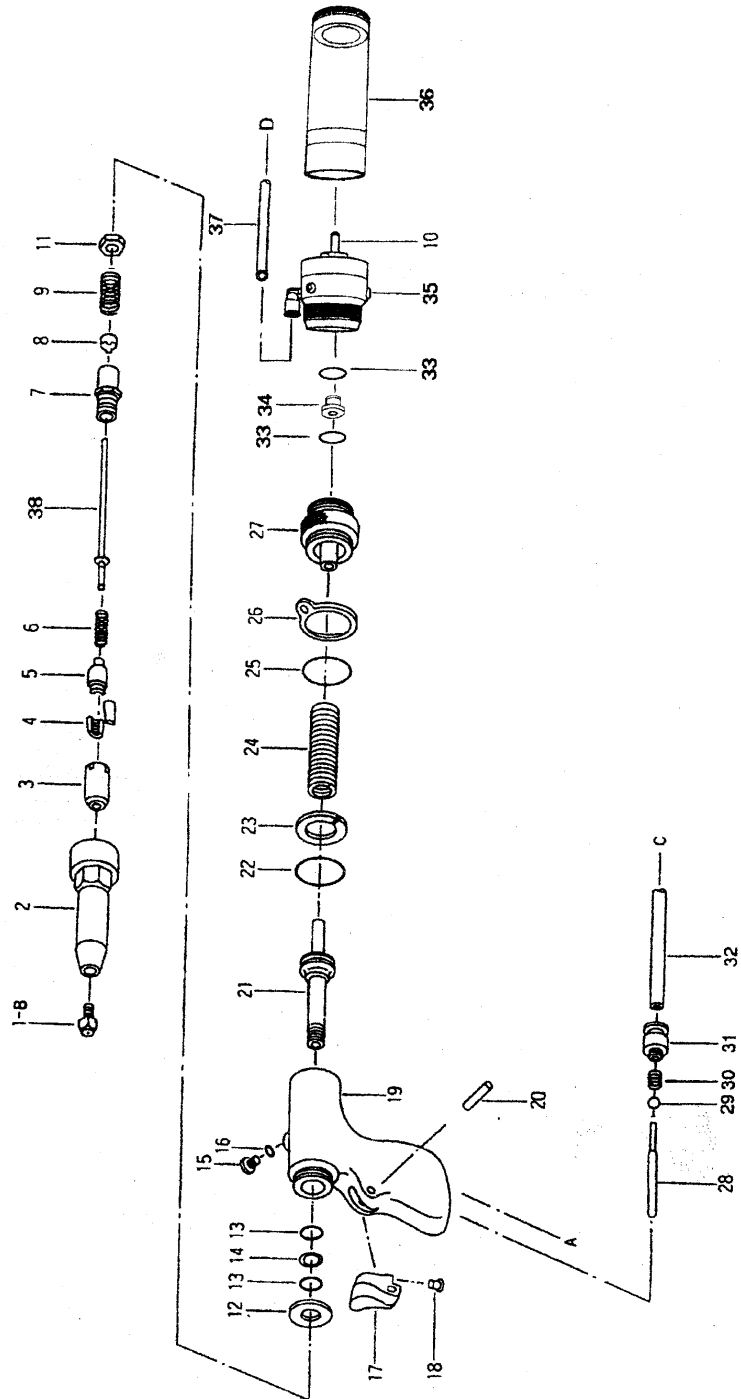

7. Part Drawing

No.	Part Name	Part No.	No.	Part Name	Part No.
1-B	Nosepiece 3.2	10028	21	Oil Piston	23627
2	Frame Head	10105	22	Urethane O-ring P-22	25443
3	Jaw Case Head	10280	23	B-ring P-22	10181
4	Jaw (Hard tool material, Medium)	10281	24	Returning Spring	23632
5	Jaw Pusher	10132	25	O-ring S-24	10185
6	Jaw Pusher Spring	10133	26	Hanger	10106
7	Jaw Case	10279	27	Frame Cap	24013
8	Collar	10286	28	Push Rod	23667
9	Collar Spring	10287	29	Urethane Ball 1/4	23669
10	Nozzle Unit	29090	30	Babble Spring	10248
11	Jaw Case Lock Nut	23640	31	Straight Joint	23671
12	Stop Ring	23634	32	Air Tube 4 dia. × 2.6m	23672
13	O-ring P-12	10128	33	O-ring S-7	12114
14	B-ring P-12	10129	34	Collar	23720
15	Oil Retaining Screw	12135	35	Vacuum Unit (U)	23763
16	O-ring P-5	12120	36	Tank Unit	24379
17	Trigger (U)	23692	37	Air Tube 6 dia. × 3m	23726
18	Thin Flat Rivet 2.5 × 5	23642	38	Guide Pipe A (U)	29110
19	Frame (U)	23635			
20	Spring Pin 3 dia. × 18	10145	Optional	Chute Hose for M	10381

No.19 includes No.12 x 1, No. 13 x 2 and No. 14 x 1.

No.17 includes No. 18.

No.35 includes No. 10 x 1.

ACCESSORIES

No.	Part Name	Part No.
1-A	Nosepiece 2.4	10027
1-C	Nosepiece 4.0	10029
1-D	Nosepiece 4.8	10030
201	Spanner A	10141
202	Spanner B	10142
204	Hose Joint 1/4"	10140
205	Cap Nut 1/4"	10139
206	Hydraulic Oil	10012
207	Guide Pipe B (U)	29111

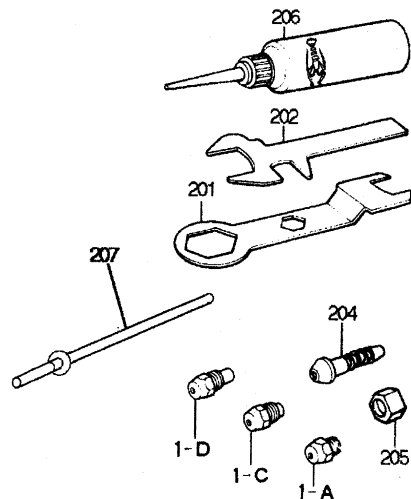

7.2 SWIVEL UNIT AND BOOSTER UNIT

Swivel unit and booster unit are consisted of the following parts:

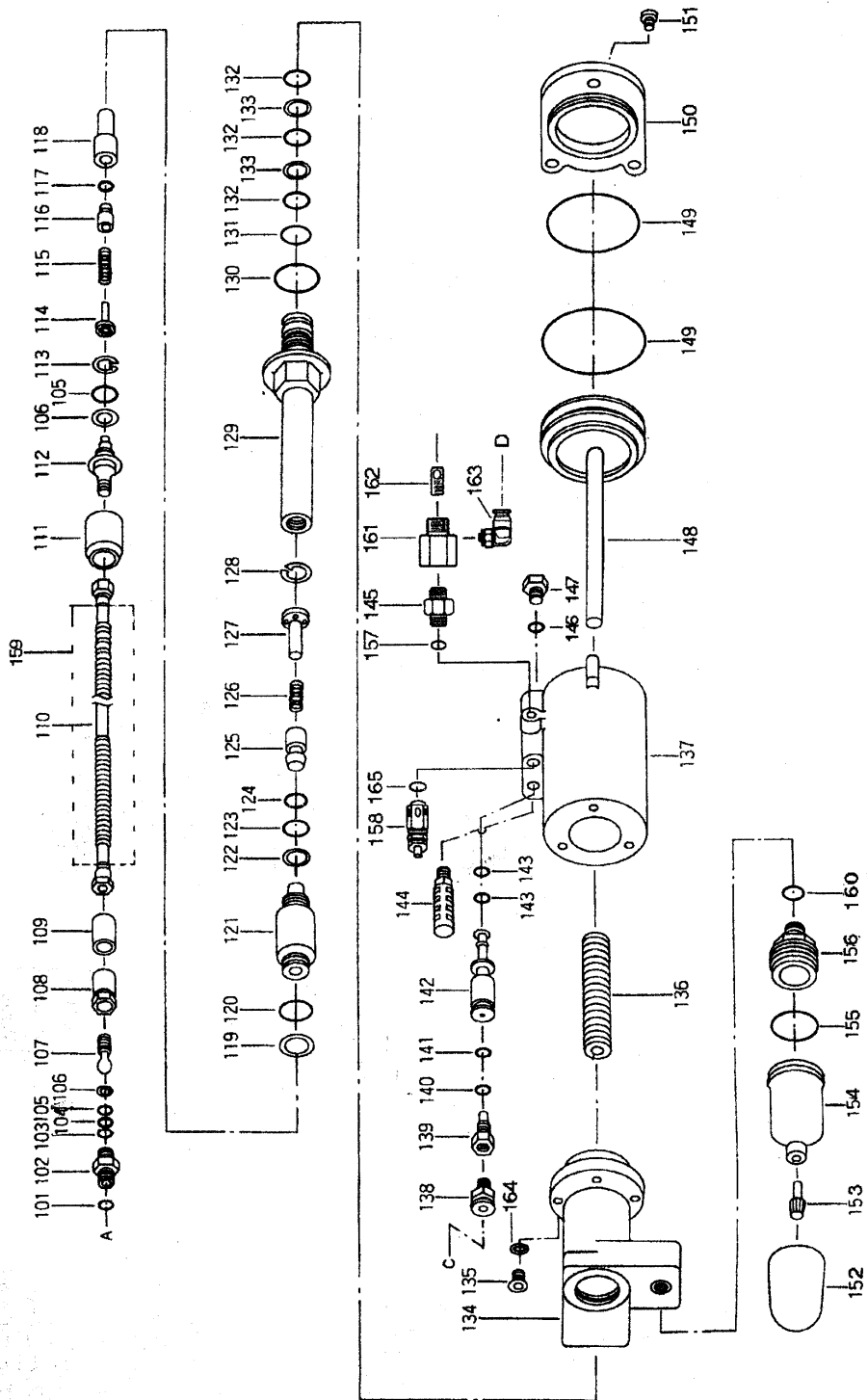

7. Part Drawing

No.	Part Name	Part No.	No.	Part Name	Part No.
101	O-ring P-11	23663	136	Oil Cylinder Joint	23700
102	O Swivel Joint	23662	137	Button Bolt with Hexagon Hole M6 x 20	23701
103	O-ring S-14	10152	136	Returning Spring	23691
104	O-ring P-10A (Cut)	23738	137	Air Cylinder	23706
105	O-ring P-14	10434	138	Straight Joint	10273
106	B-ring P-14	10435	139	Spool Cap B	23708
107	Swivel Shaft	23658	140	O-ring S-12	23709
108	Swivel Case	23660	141	O-ring P-8	10336
109	Rubber Bellow	28490	142	Spool	23707
140	Hydraulic Hose	23644	143	O-ring P-5	12120
111	Coupler Bag	23652	144	Silencer	23689
112	Coupler Male Joint (U)	23713	145	Nipple	14484
113	C-type Stop Shaft for hole RTW-18	23646	146	O-ring S-12	23709
114	Coupler Spring Shaft	23655	147	Spool Cap A	23688
115	Spring	10133	148	Air Piston (U)	23679
116	Valve	23648	149	O-ring P-85	10452
117	O-ring P-6	10150	150	Air Cylinder Cap	23678
118	Coupler Male Case	23654	151	Bolt with Hexagon Hole M6 x 15	23690
119	B-ring P-21	23718	152	Oil Tank Cap	15606
120	O-ring P-21	23711	153	Cap	15819
121	Coupler Female Case	23716	154	Oil Tank	15644
122	B-ring P-18	23684	155	O-ring G-30	12445
123	O-ring P-18	23683	156	Oil Tank Base	23693
124	O-ring P-6	10150	157	O-ring P-9	10219
125	Valve	23648	158	Safety Valve (U)	25467
126	Spring	10133	159	Protection Tube	23668
127	Coupler Spring Shaft	23655	160	O-ring P-12	10128
128	C-type Stop Shaft for Hole RTW-18RTW-46	23712	161	Branch Plug	22029
129	Oil Cylinder (U)	23682	162	Fixing Screw	22030
130	O-ring S-30	23685	163	L-type Joint	22034
131	O-ring P-24	10207	164	Plain Washer (M6)	24426
132	O-ring P-14	10434	165	O-ring S-11	25590
133	B-ring P-14	10435			

No.129 includes No. 130 x 1, No. 131 x 1, No. 132 x 3 and No. 133 x 2.

No.148 includes No. 149 x 1.

No.158 includes No. 165.

STORAGE

This tool must be stored in less dust, less humid and drafty place on solid floor.

If this tool is not used for a long time, clean up each part of the tool according to “Section 5 Cleaning and Maintenance”, and store it.

To use the tool longer, we recommend you to request us overhaul service periodically.

(Overhaul is not a free-of-charge service) Consult the store you purchased this tool or Lobtex local sales office about overhaul service and other maintenance service.

ORDERING PARTS

Clearly identify the model No, part No, and quantity in the order sheet, and submit it to the store you purchased this tool or directly to Lobtex local sales office. (You may refer “7 Part drawing.”)

Model No.	Part No.	Part name	Q'ty
ARV-022M	10281	Hard tool material Jaw, Medium	1 set
ARV-022M	10105	Frame Head	1 set

Even when the part is improved, the inventory of the previous part will be available for 5 years.

LOBTEX CO.,LTD.

LOBTEX Home Page

<http://www.lobtex.co.jp>

OsakaNishi Mazda Idg. 8th FL.
3-25, Sakuragawa 1-Chome,
Naniwa-KU, Osaka 556, Japan

TEL(0729)80-1111 FAX(0729)80-1166
